

77

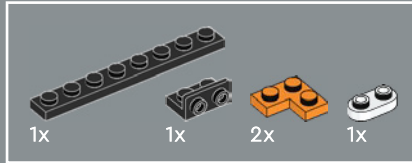

78

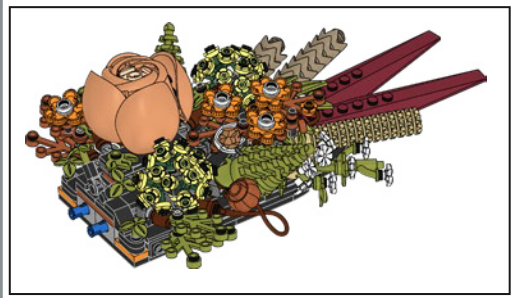

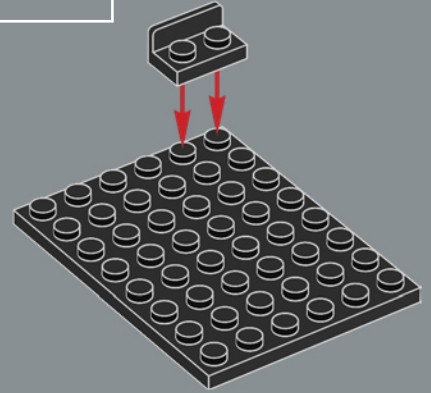
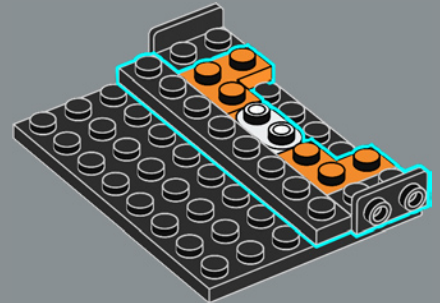
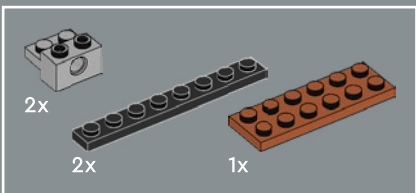

79

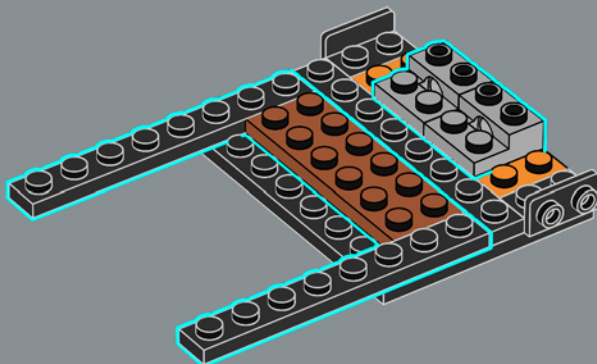

80

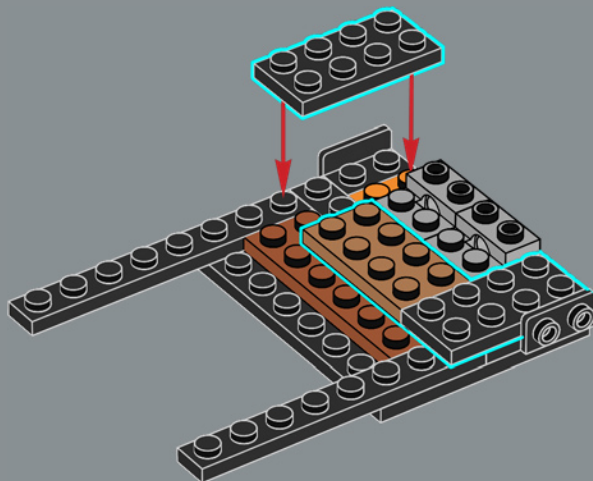

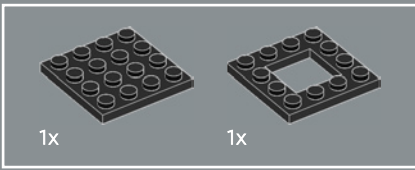

81

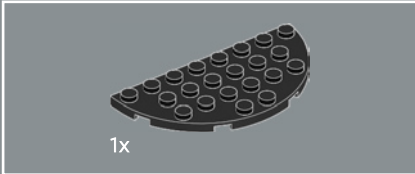
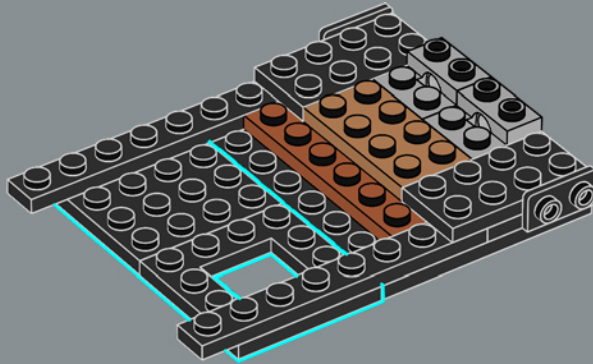

82

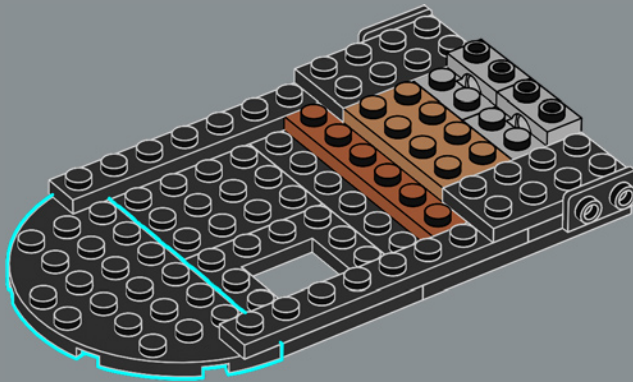

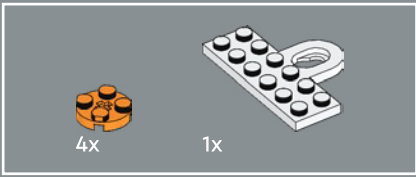

83

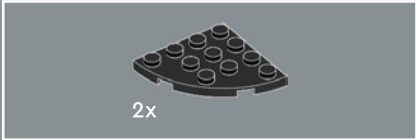
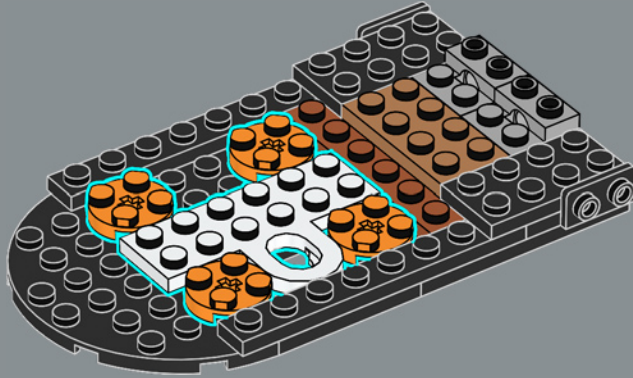

84

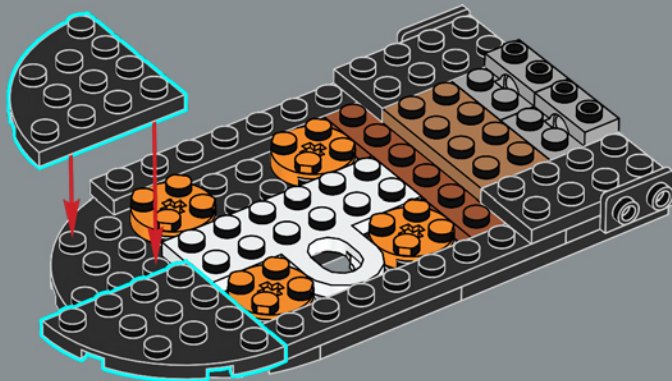

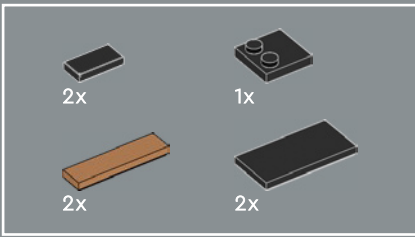

85

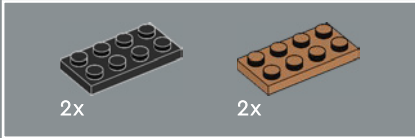
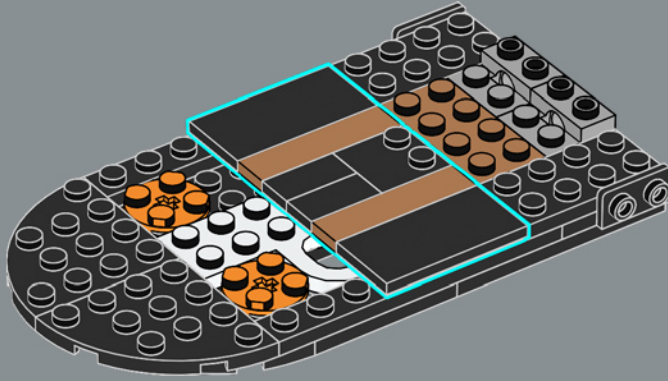

86

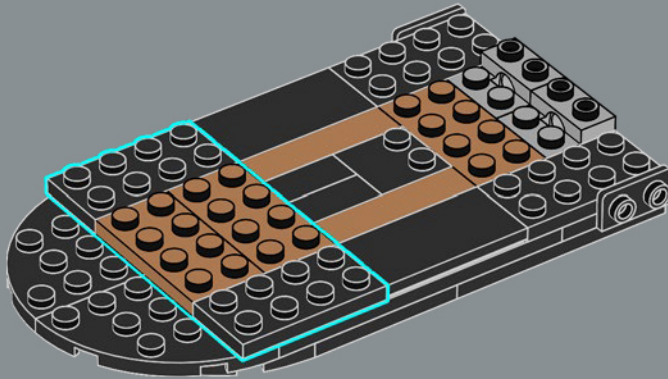

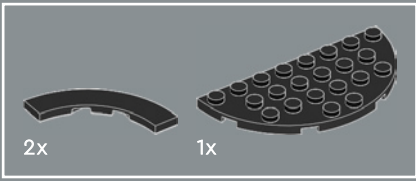

87

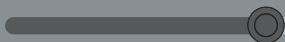
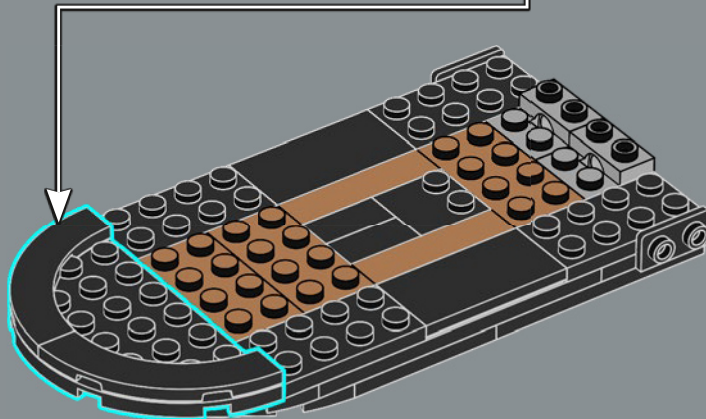
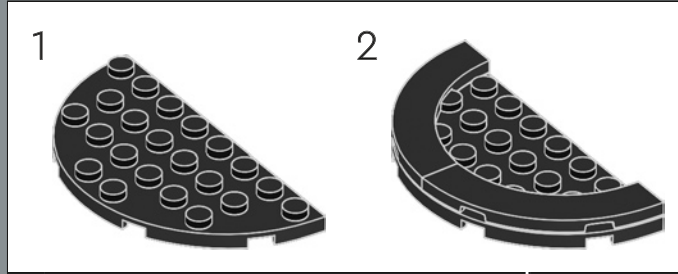



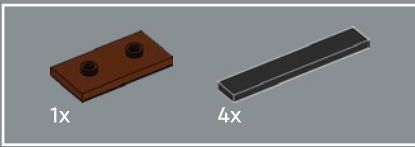

88

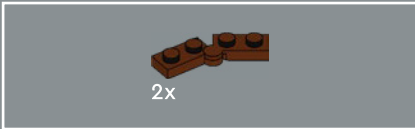
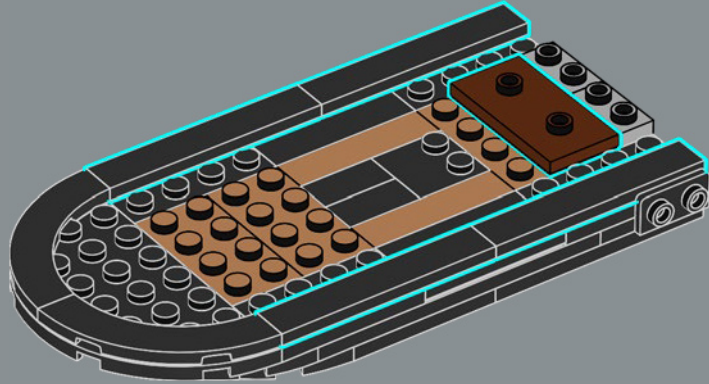

89

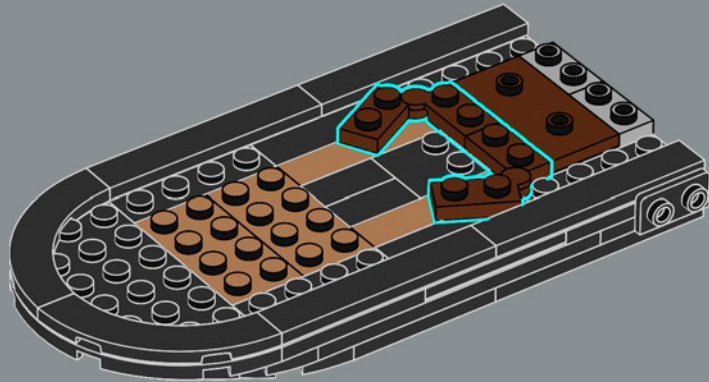

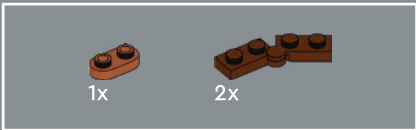

90

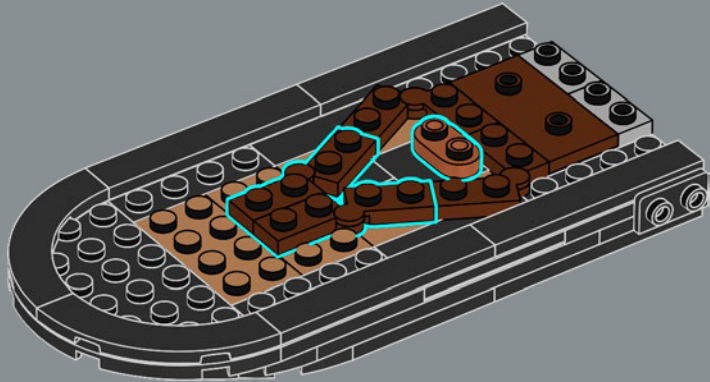

91



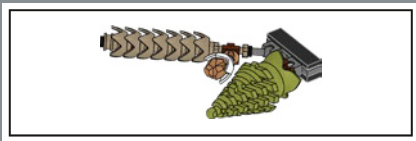

92

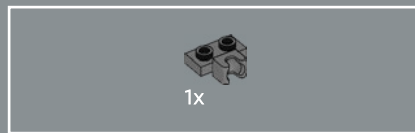
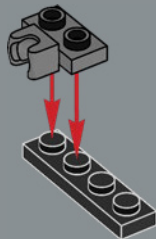

93

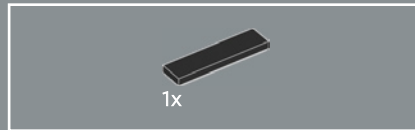
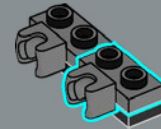

94

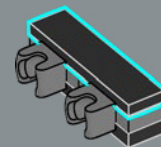



95

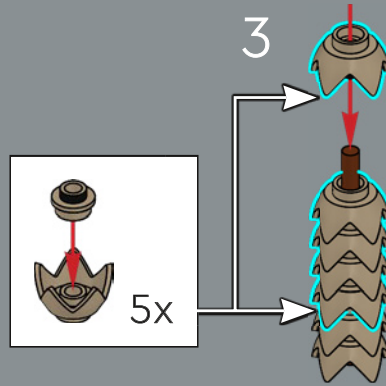
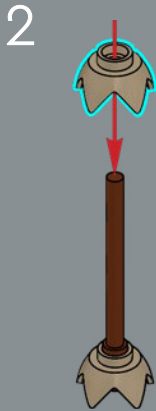
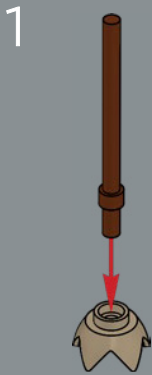



96

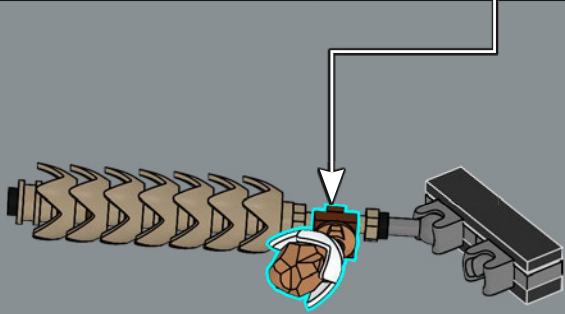

The stalks of wheat use nested crown elements to give the wheat its corrugated appearance.

Les tiges de blé utilisent des éléments de couronne imbriqués pour donner au blé son aspect ondulé.

El trigo tiene coronas anidadas para replicar el aspecto corrugado de las espigas.

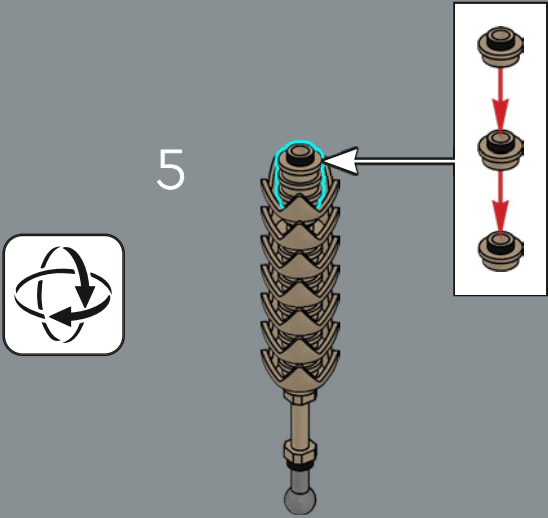

5

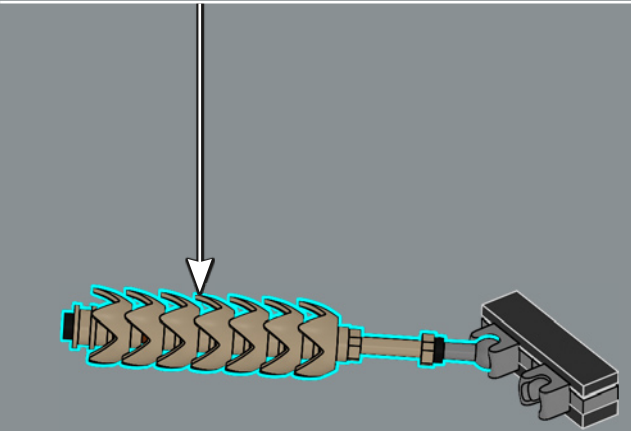

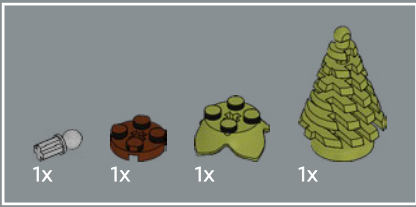

97

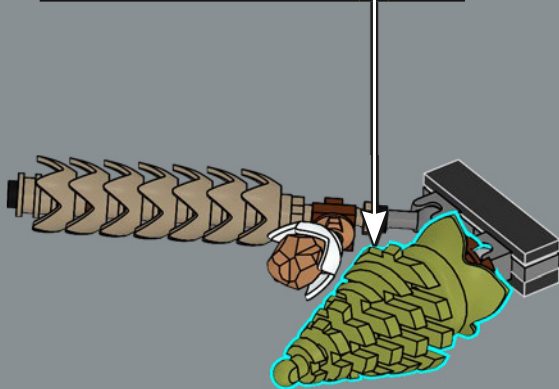
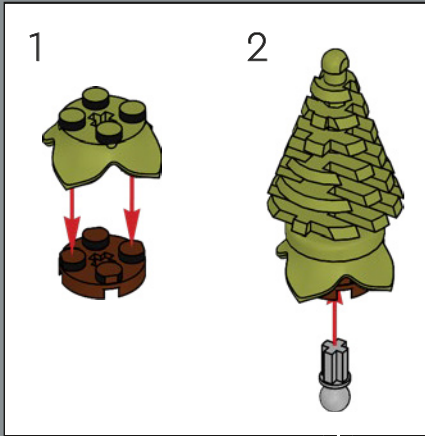

98

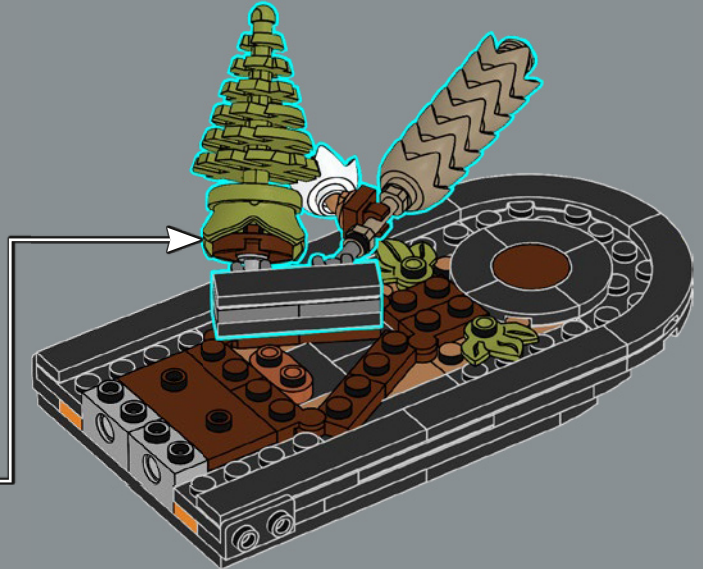

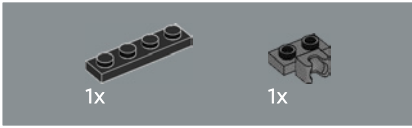
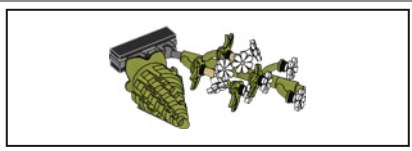

99

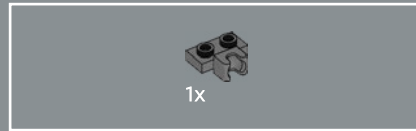
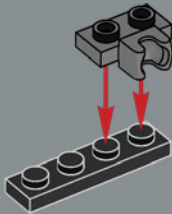

100

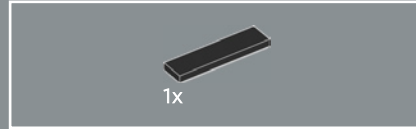
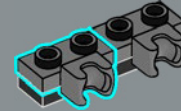

101

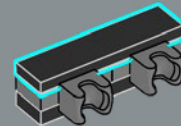

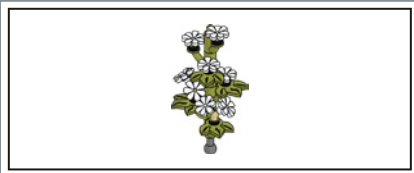

1x

2x

102



2x

103

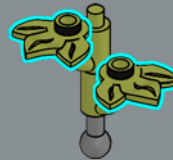

2x

4x

104

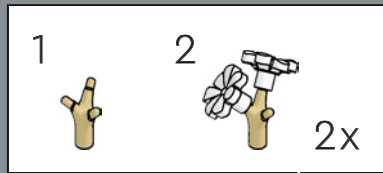

1

2

2x

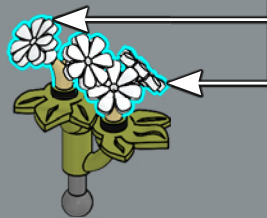





105

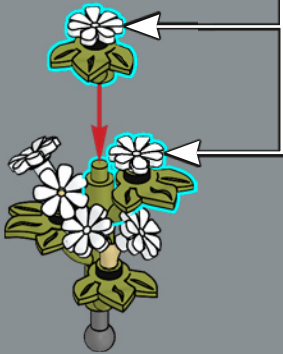
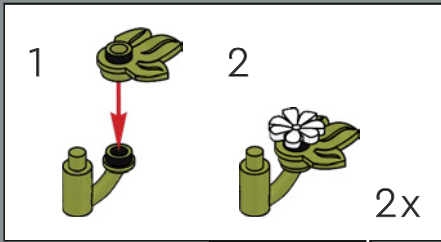

106

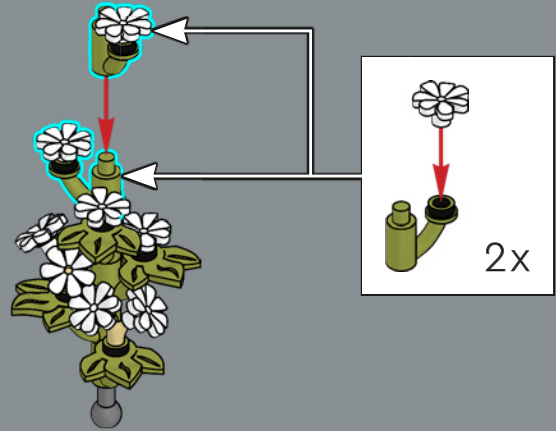

107

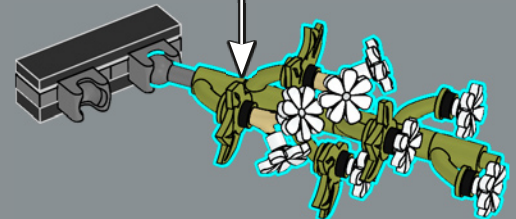

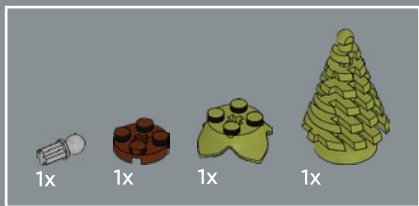

108

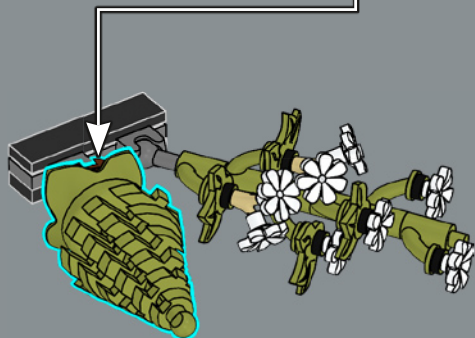
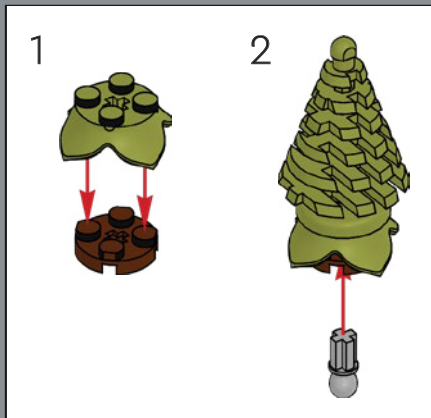

109

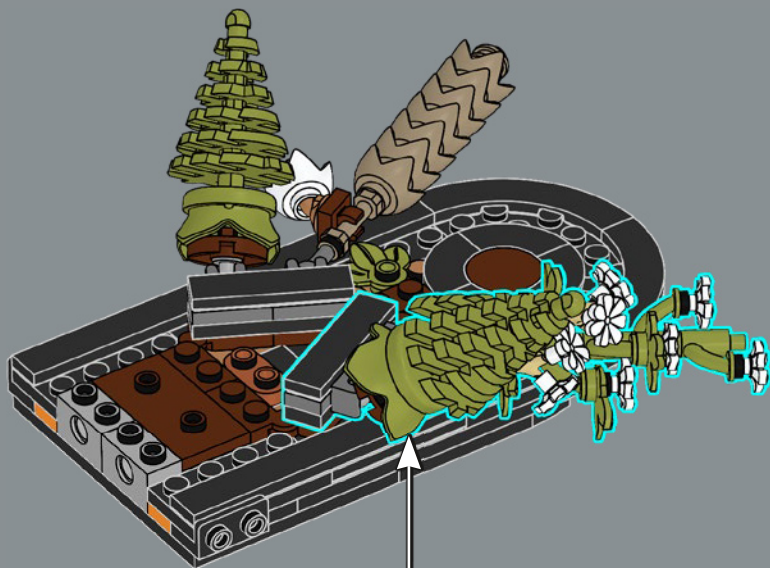

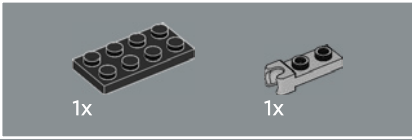
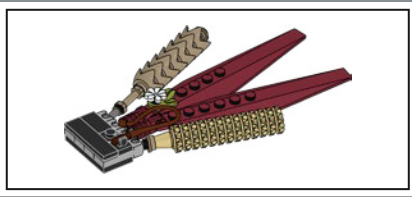

1x

1x

110

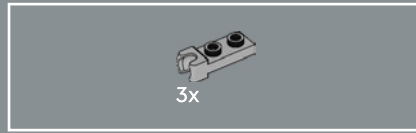

3x

111

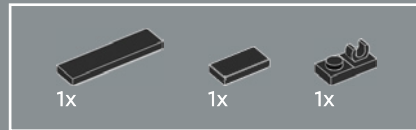
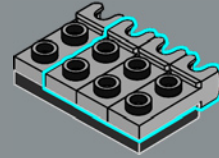

1x

1x

1x

112

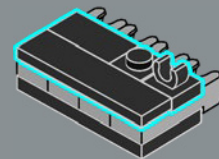

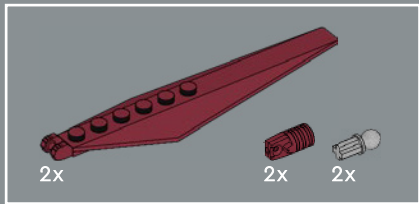

113

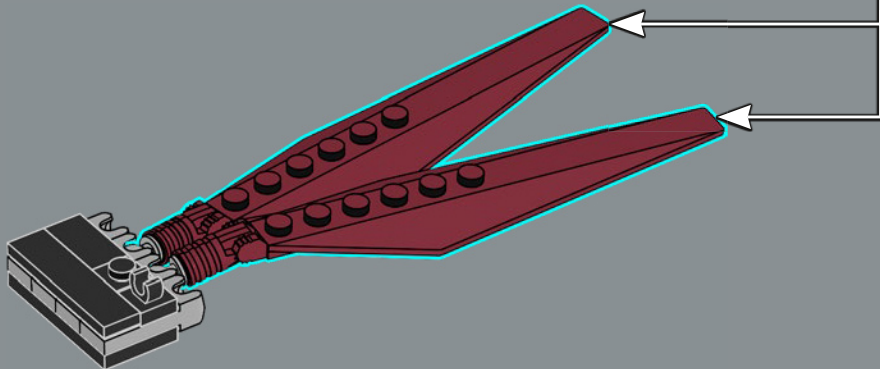
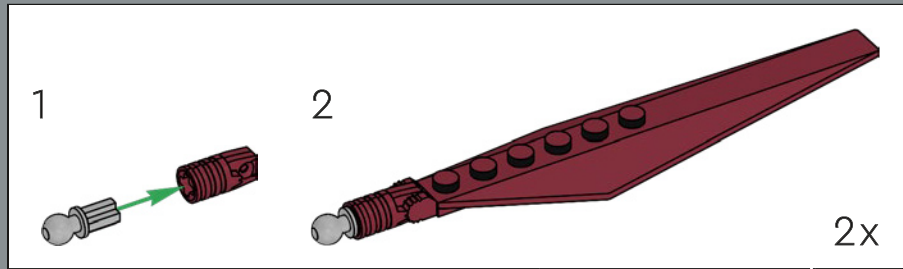

114

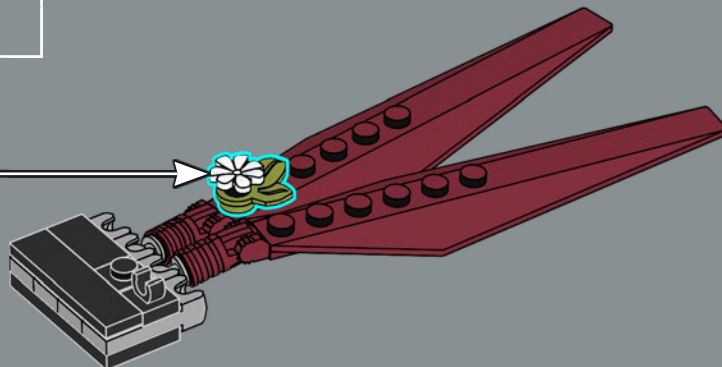
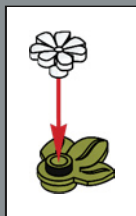



115

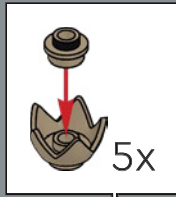
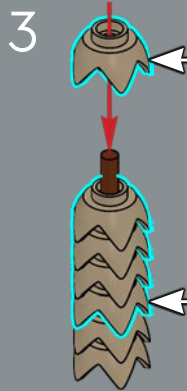
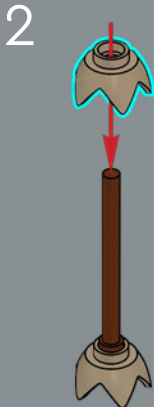
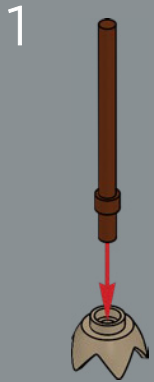

5

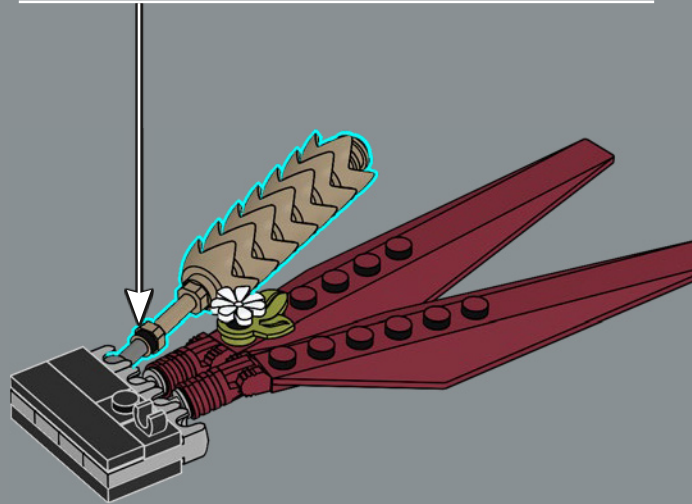
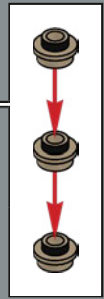

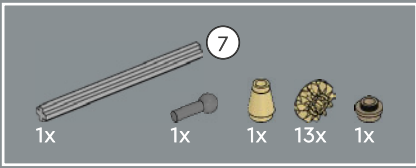

116

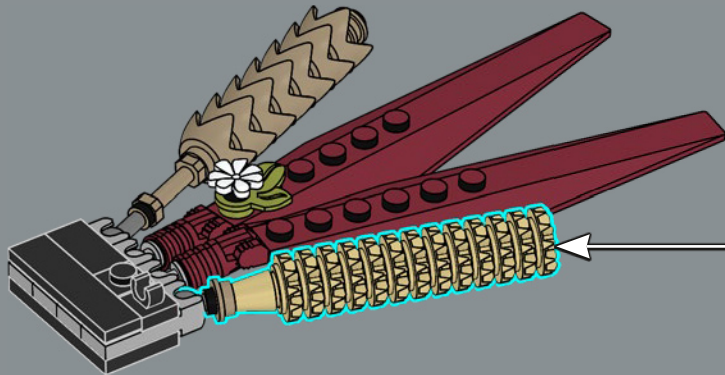
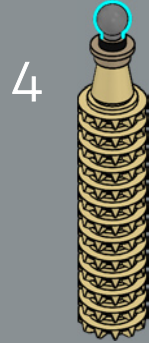
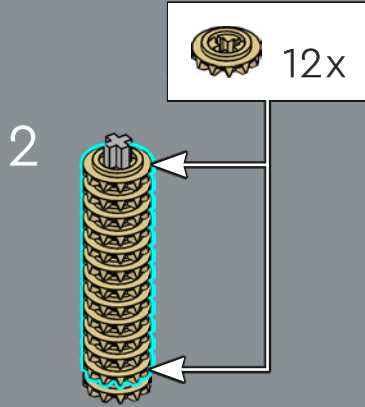
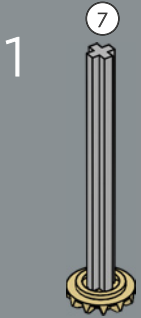



117

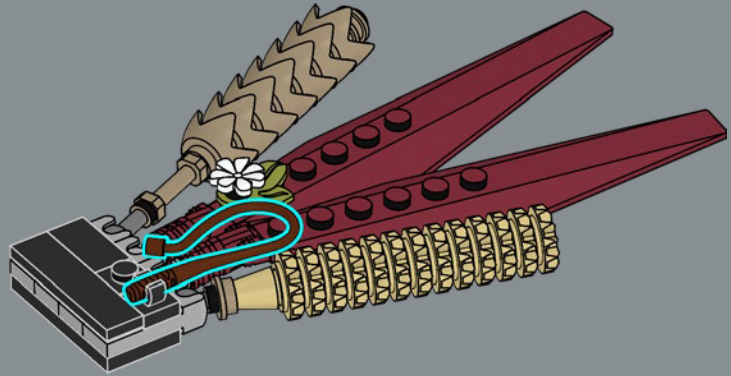

118

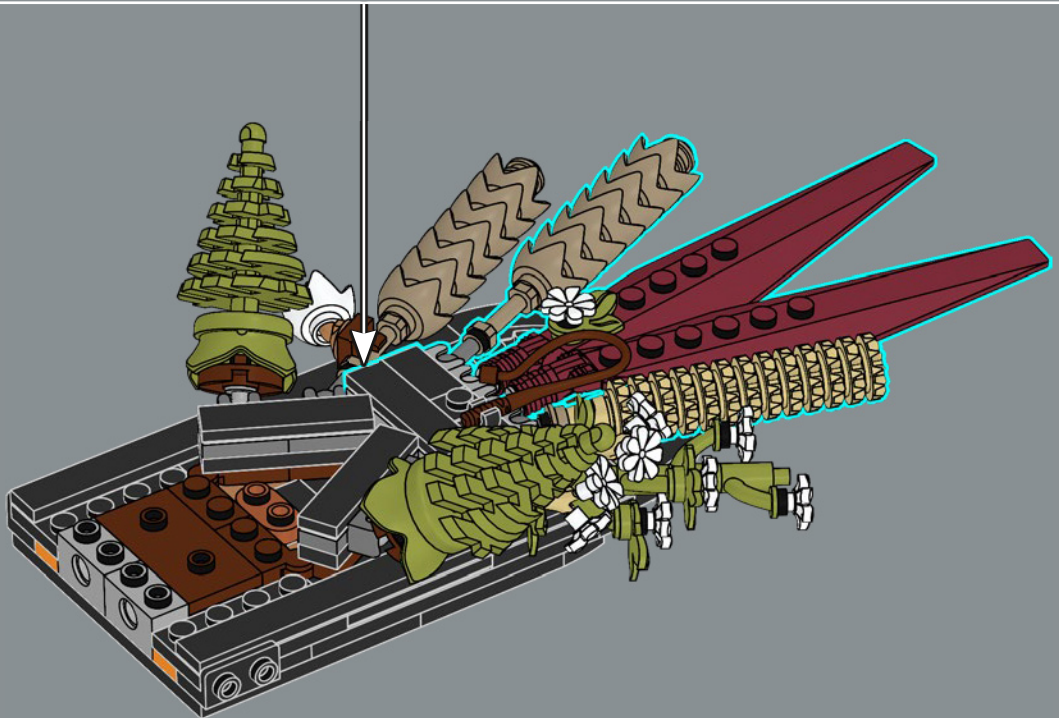

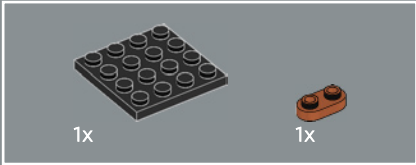
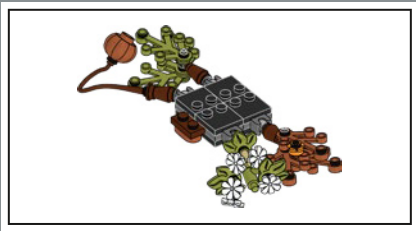

119

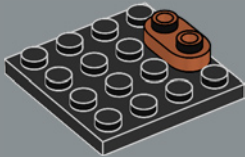

120

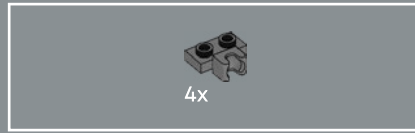
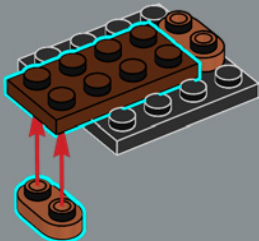

121

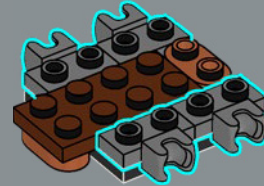

122

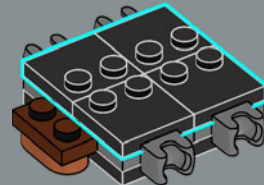





123

1

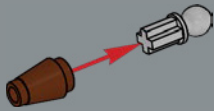

2

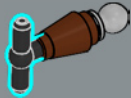

3

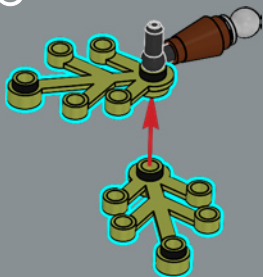

4

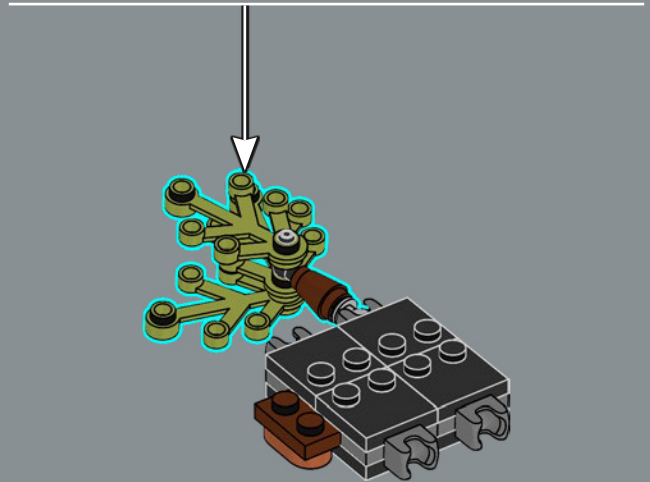
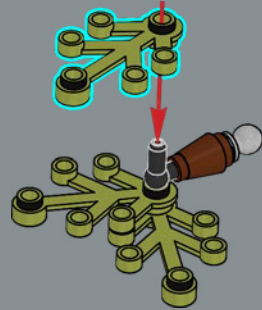



124

1

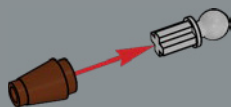

2

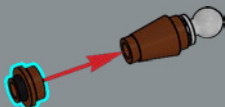

3

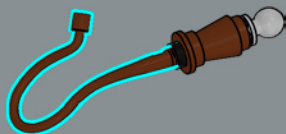

4

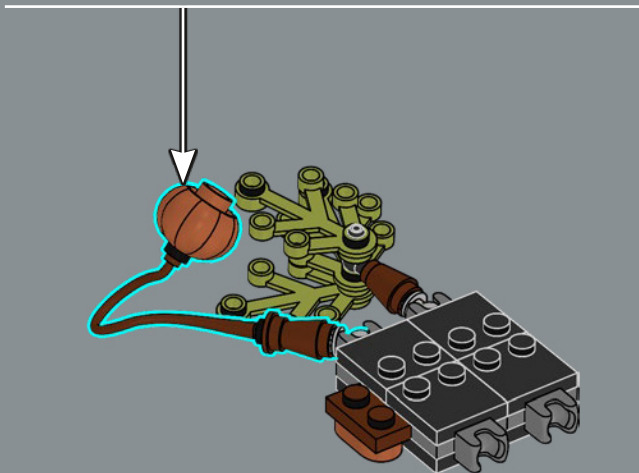
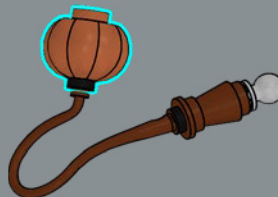

The peculiarly named bladder cherry is built with a LEGO® element that is usually used as vegetables, (like pumpkins or lanterns) and a flexible brown whip element.

L'alkékonge est construite à partir d'un élément LEGO® habituellement utilisé pour les légumes (comme les citrouilles) ou les lanternes et d'un élément flexible brun de type fouet.

Con un nombre muy peculiar, las lanternas japonesas se construyen uniendo un elemento LEGO® habitualmente utilizado para representar verduras (principalmente, calabazas) y un látigo flexible de color café.





125

1

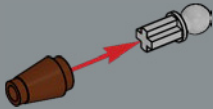

2



3

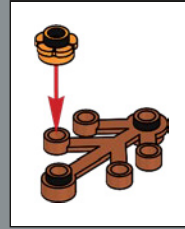
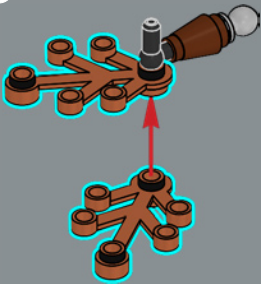

4

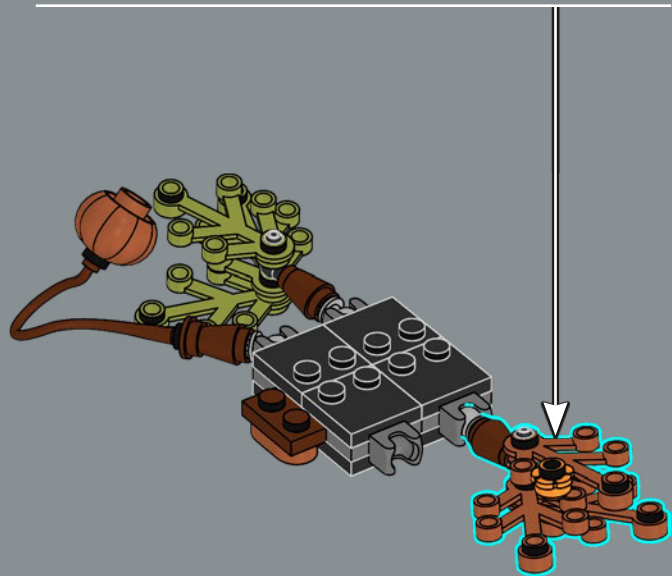

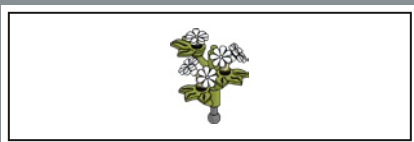

126



127

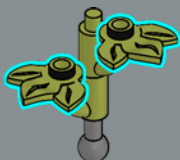

128

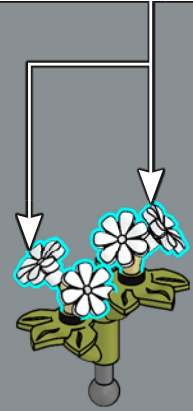
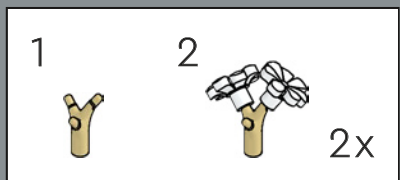



129

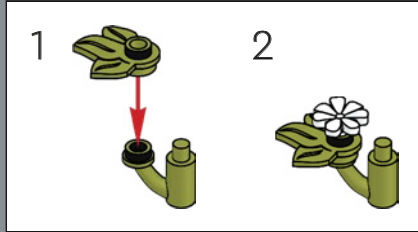

130

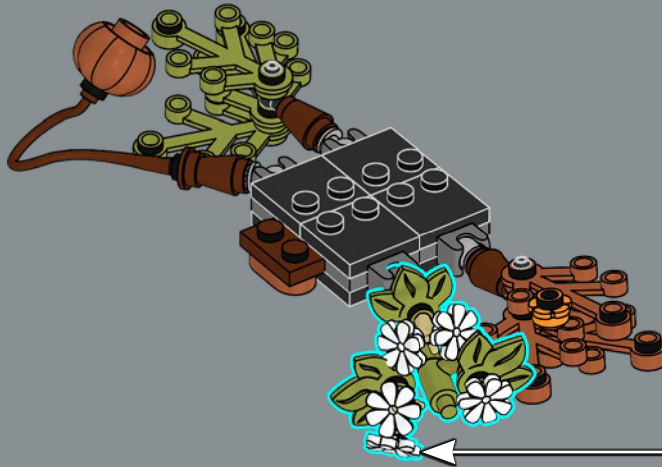

131

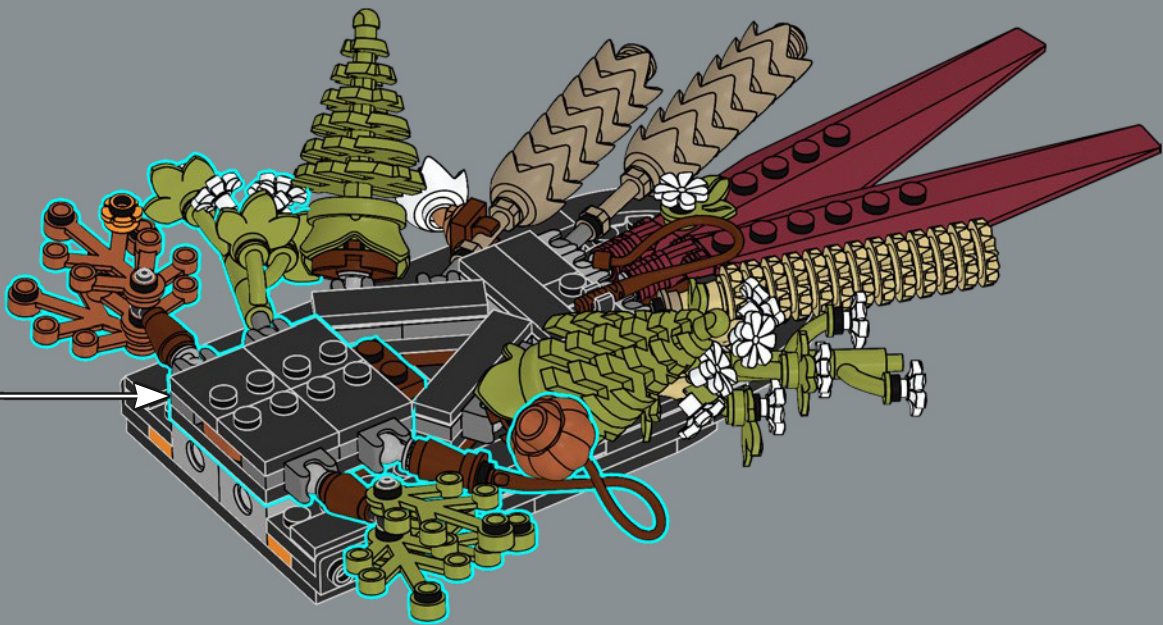

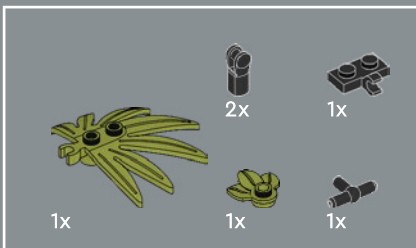

132

1

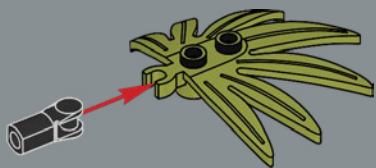

2

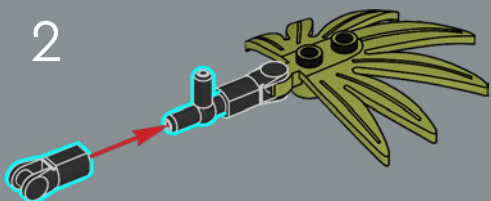

3

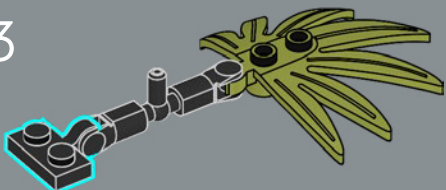

4

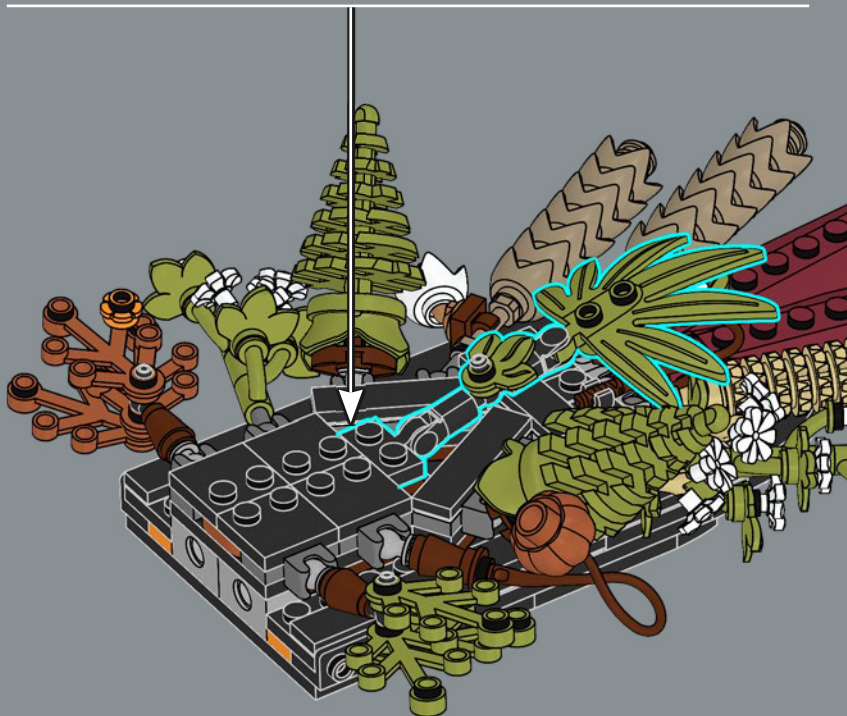
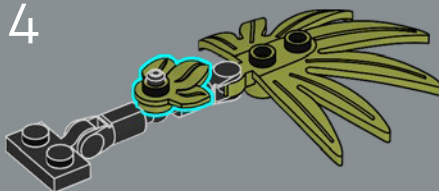

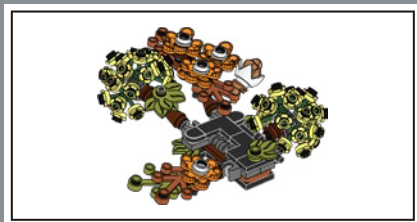

133

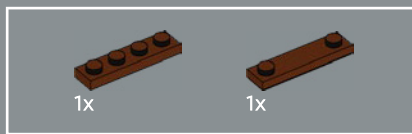
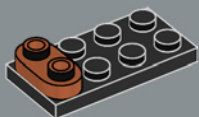

134

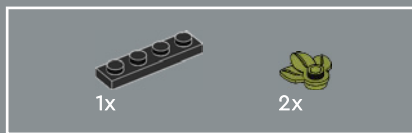
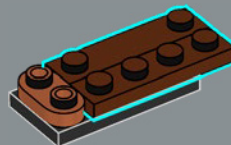

135

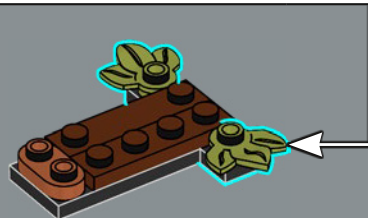
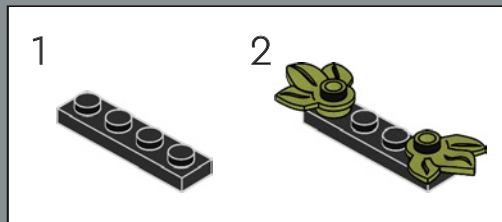



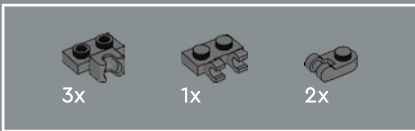

136

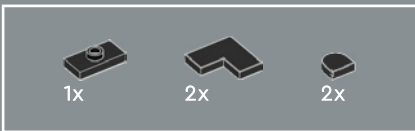
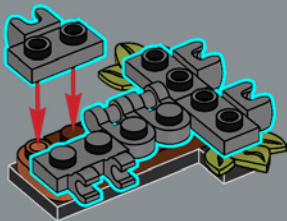

137

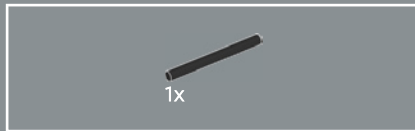
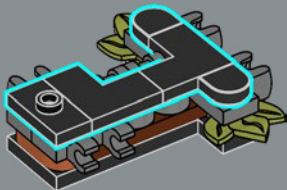

138

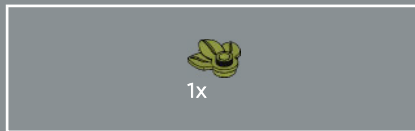
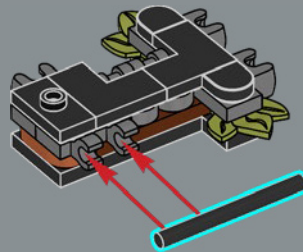

139

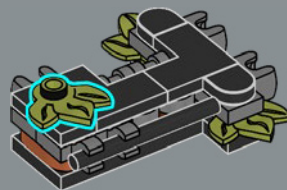



140

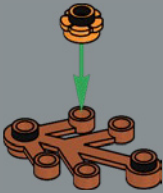

141

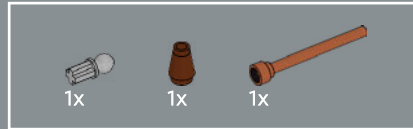
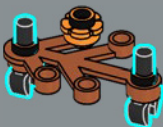

142

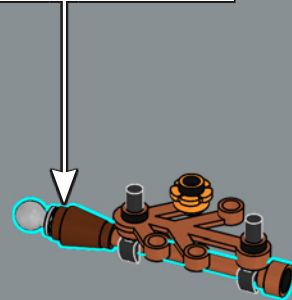
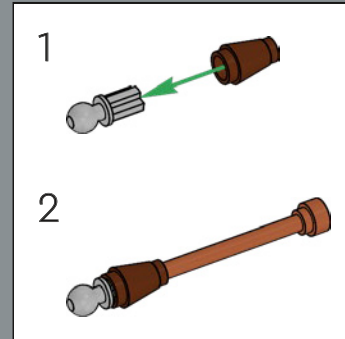

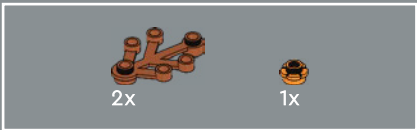

143

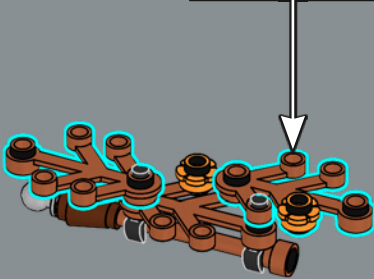
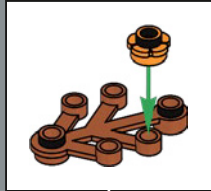

144

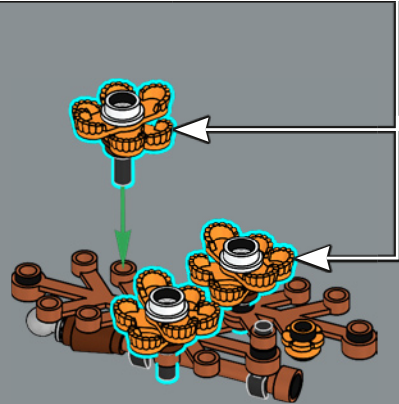
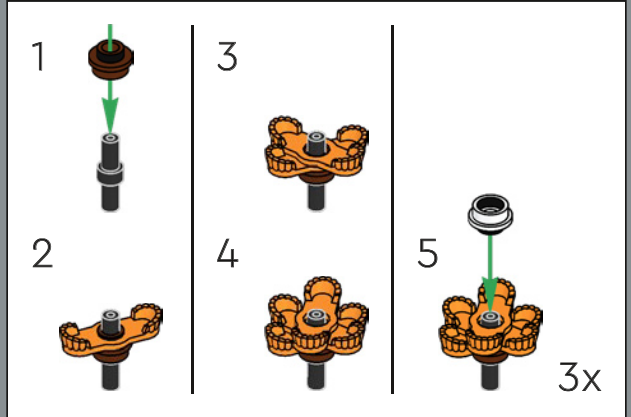



1x



1x



1x

145

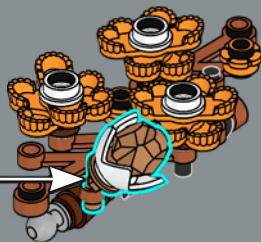
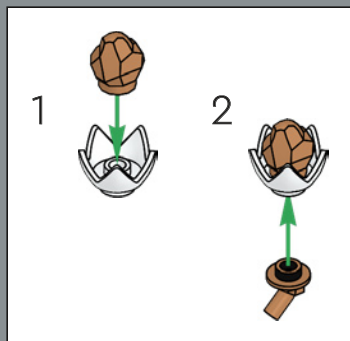

The dried daisy heads are constructed with a white crown element and a rare rock element first used as a gold nugget.

Les têtes de marguerites séchées sont construites avec un élément de couronne blanche et un élément de roche rare utilisé pour la première fois comme pépite d'or.

Las margaritas disecadas están hechas a partir de un elemento que representa una corona y una inusual pieza que se usó originalmente para representar una pepita de oro.

146

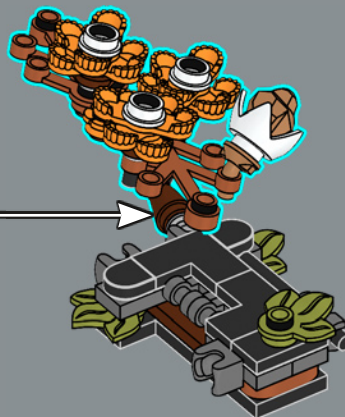

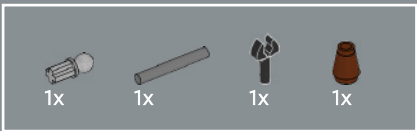

147

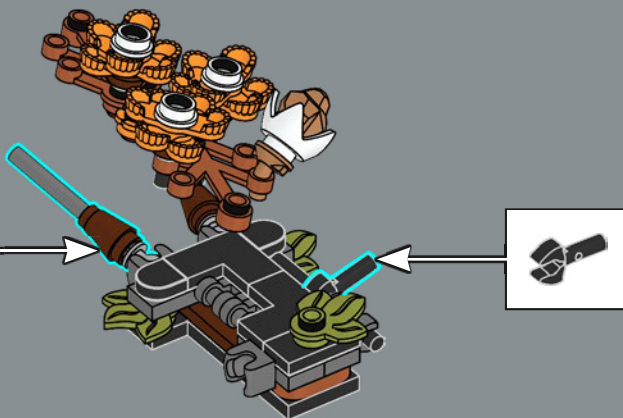
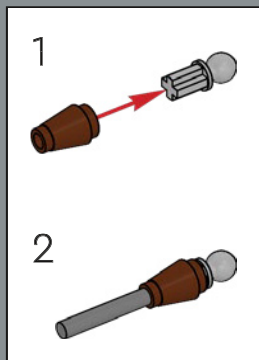



148

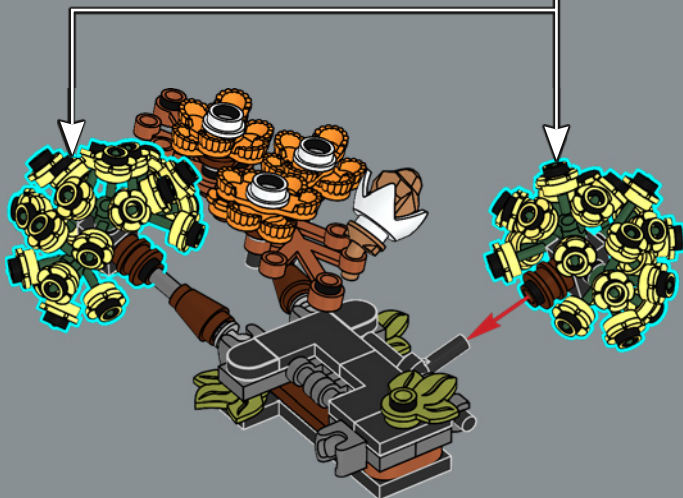
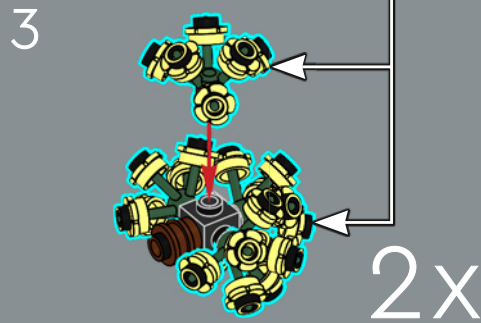
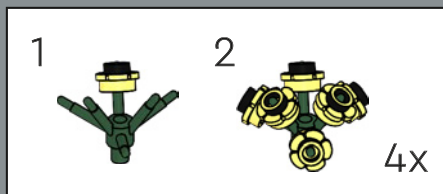
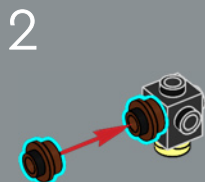
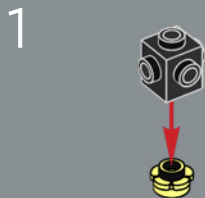



1x



2x

149

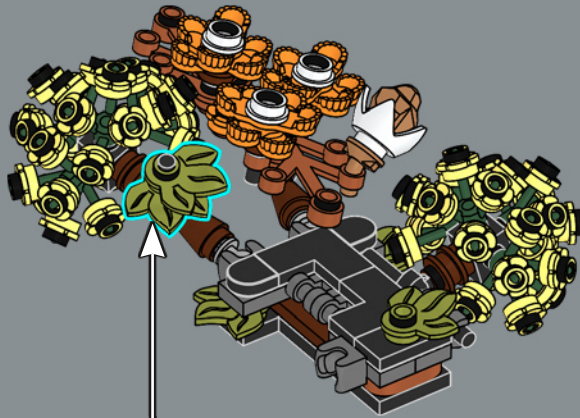

1

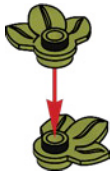

2





150

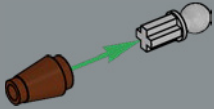

151

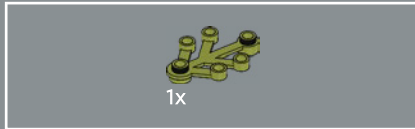
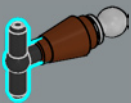

152

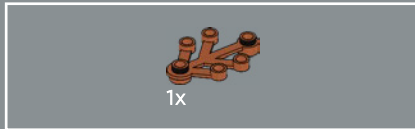
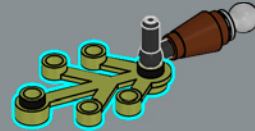

153







154

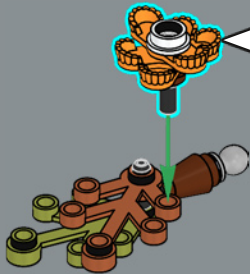
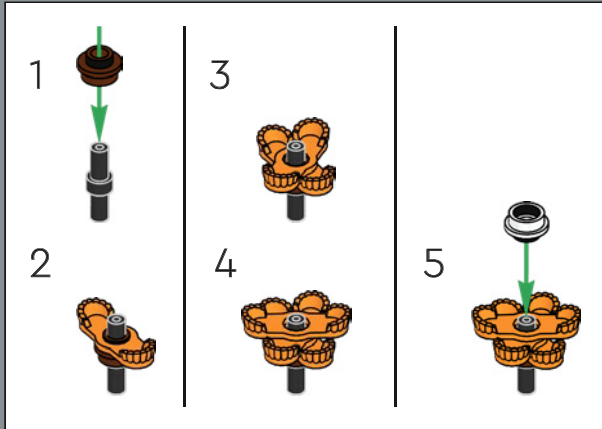

155

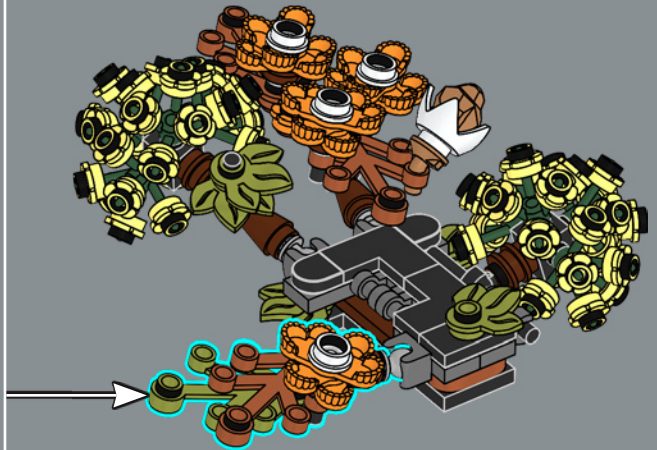

156

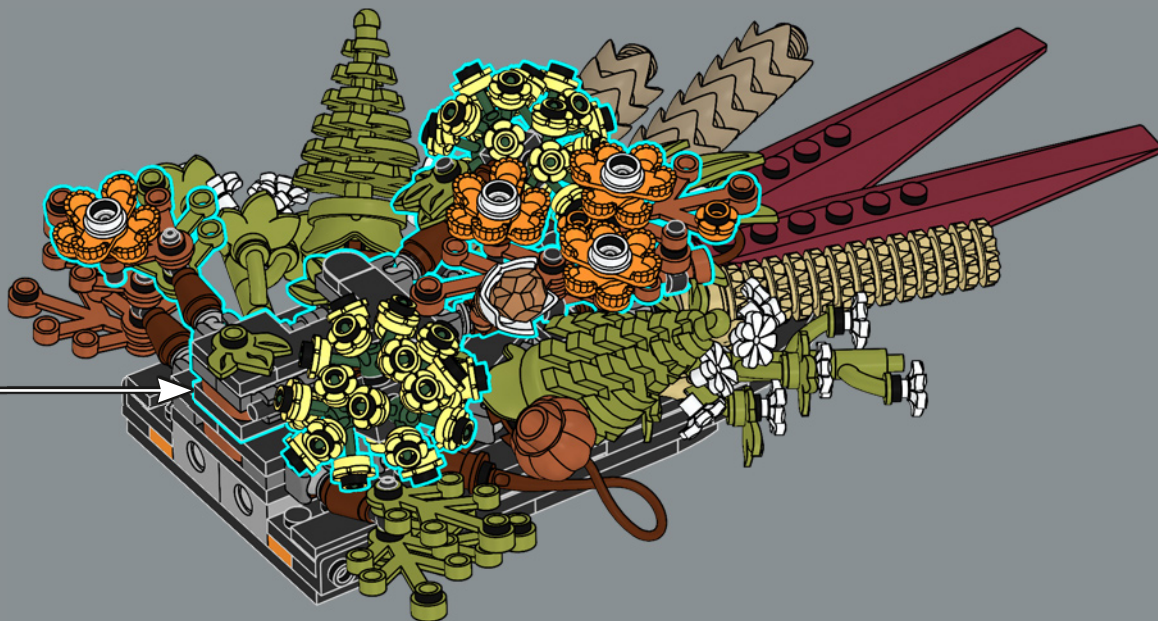

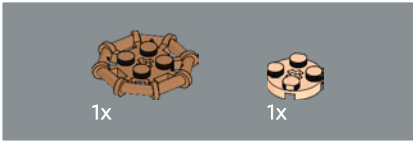
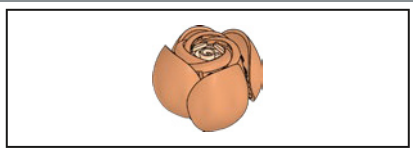

157

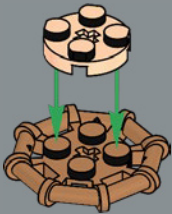

158



159

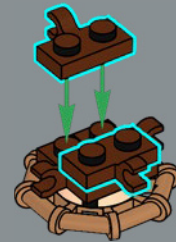

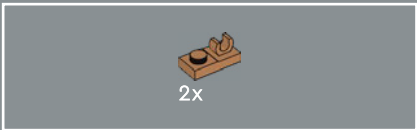

160

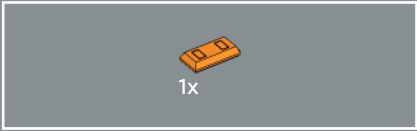
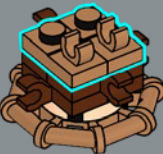

161

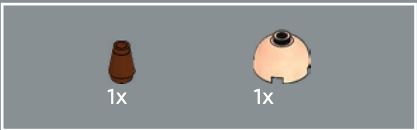

162

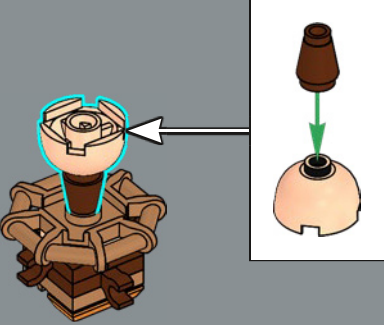

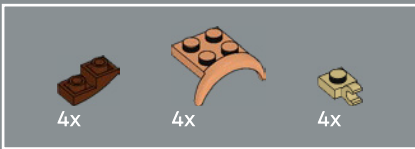

163

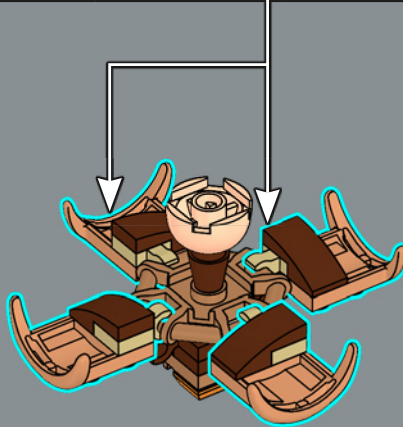
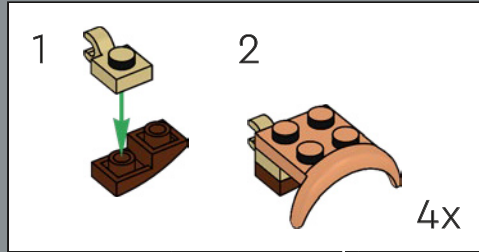

164

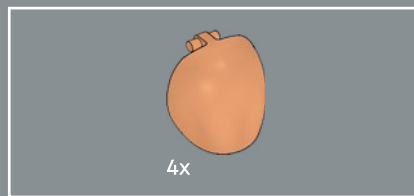
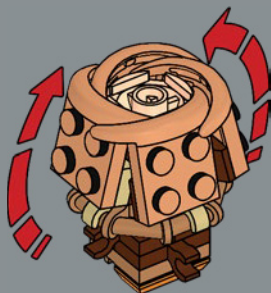

165

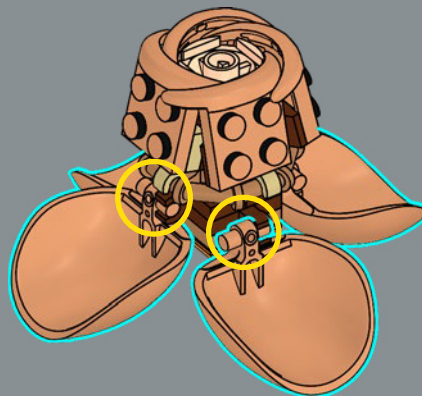

166

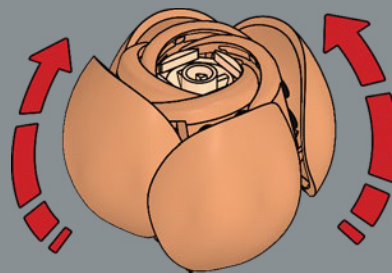



167

The intricate rose construction uses new mud guard elements for the inner petals and a new shell element for the outer petals.

La construction complexe de la rose utilise de nouveaux éléments de garde-boue pour les pétales intérieurs et un nouvel élément de coquille pour les pétales extérieurs.

La elaborada construcción de la rosa utiliza salpicaderas de autos como pétalos interiores y un nuevo elemento de cubierta para los pétalos exteriores.

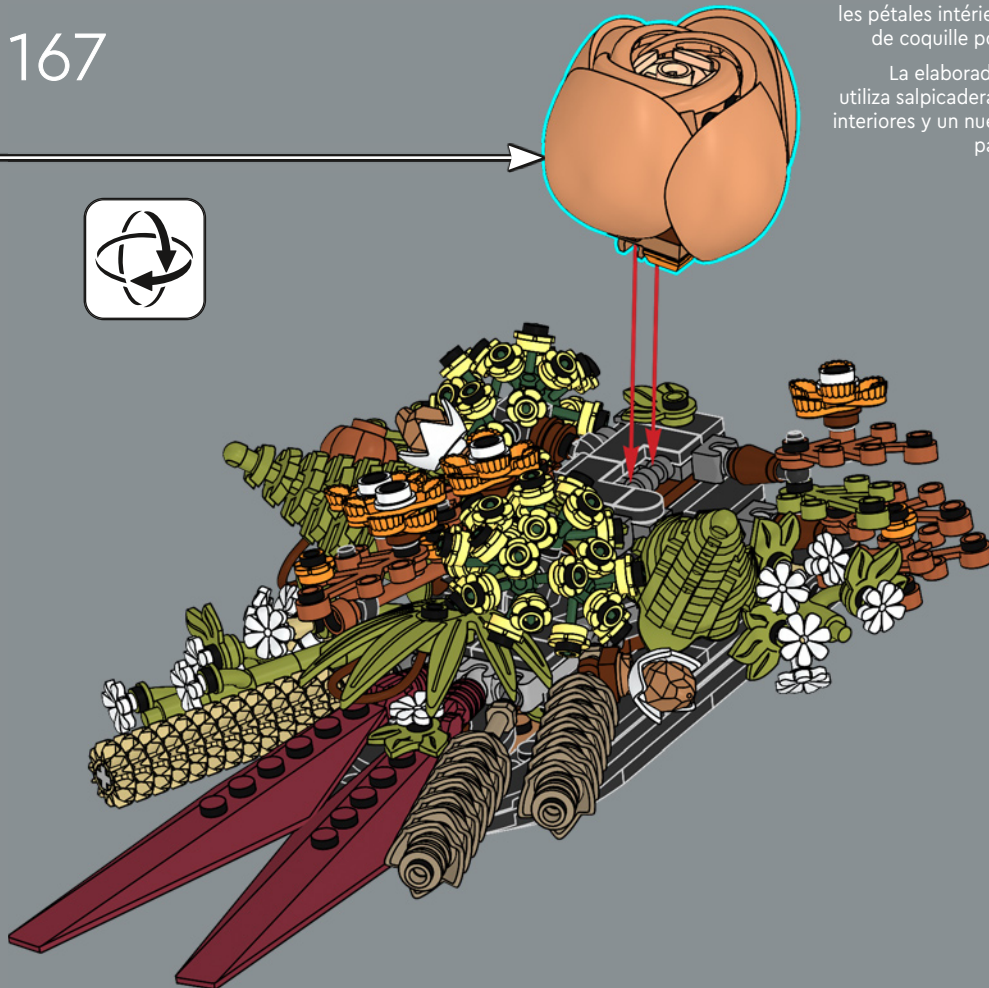





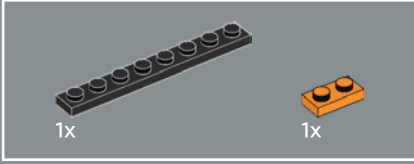
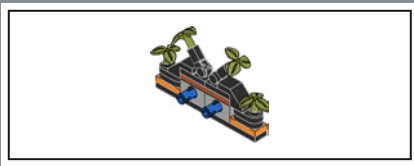

168

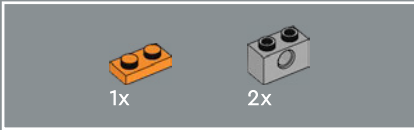
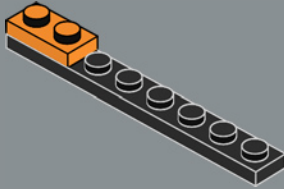

169

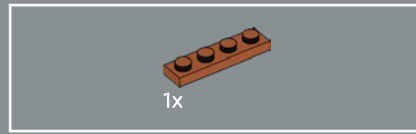
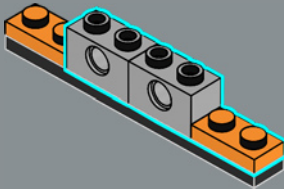

170

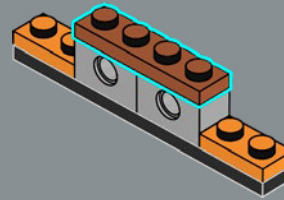

171

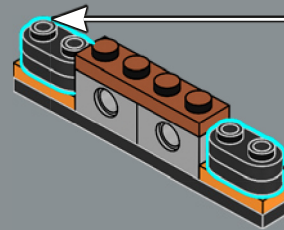
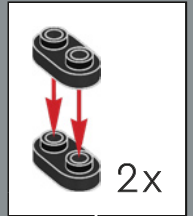



172

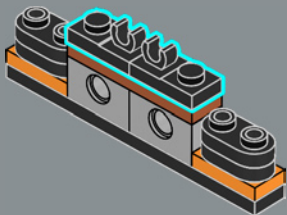

173

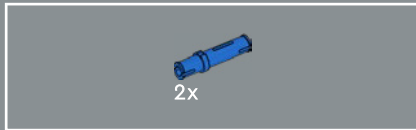
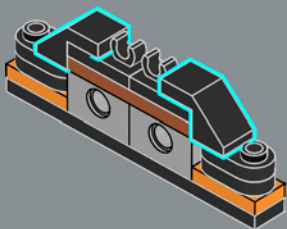

174

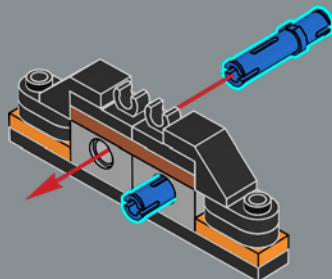



175

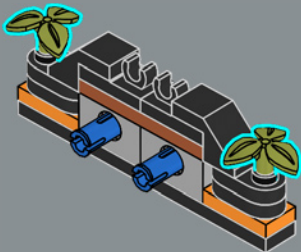

176

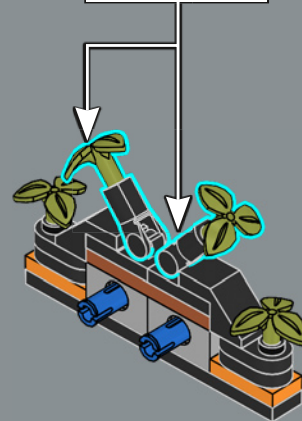
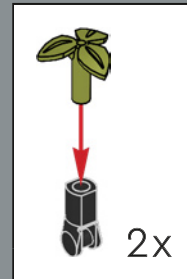

177

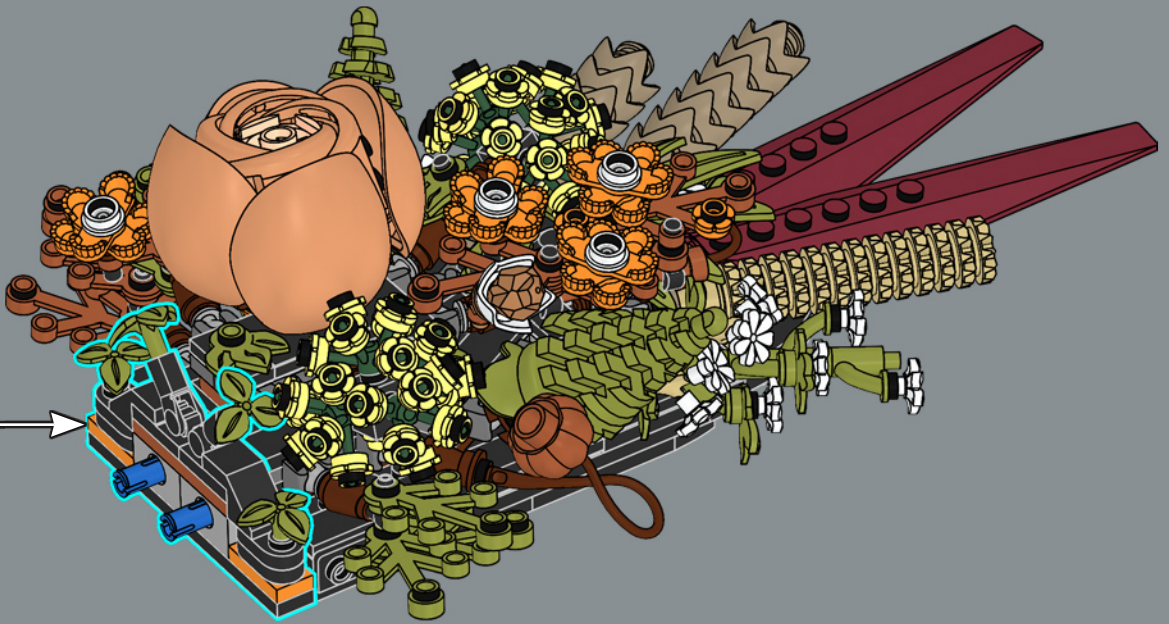



178

Dried flowers are sometimes preserved using a thin wax. The shiny elements in this set were chosen to replicate that wax look.

Les fleurs séchées sont parfois conservées à l'aide d'une fine cire. Les éléments brillants de cet ensemble ont été choisis pour reproduire cet aspect de cire.

Es común que se use una delgada capa de cera para preservar las flores desecadas. Los elementos brillantes de este set fueron elegidos con el fin de replicar el aspecto encerado.

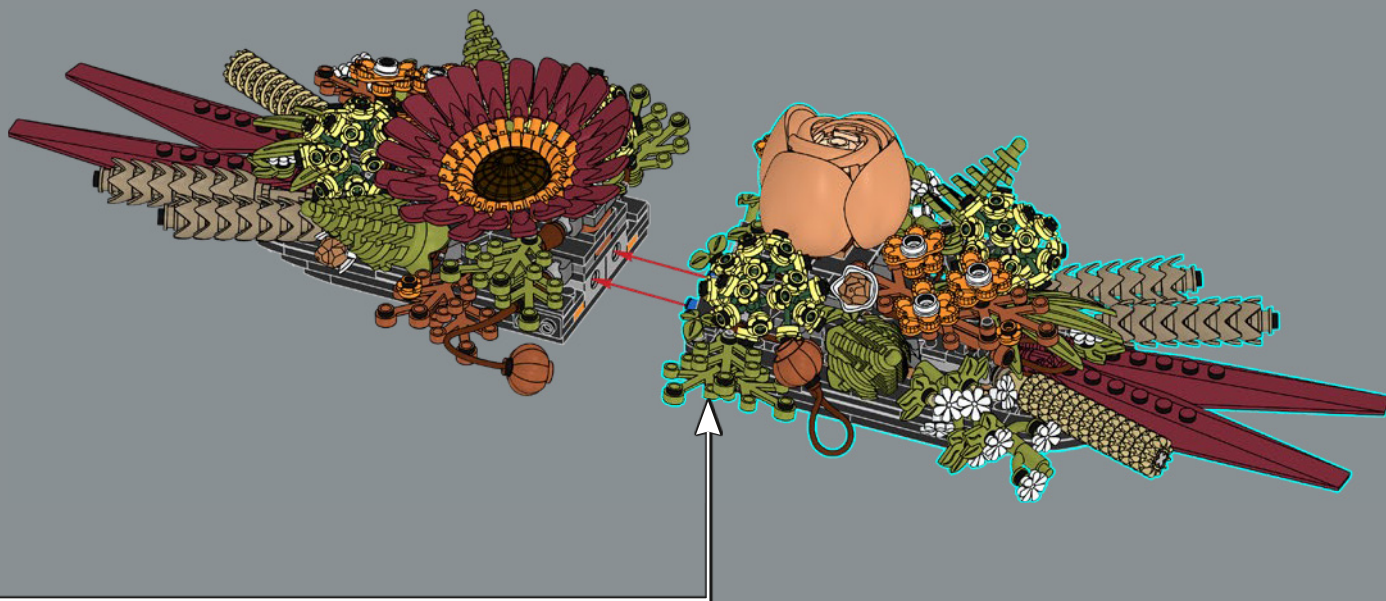

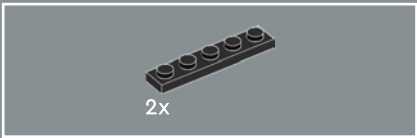

179

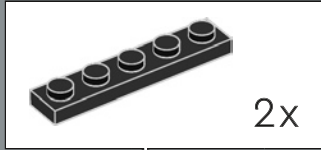

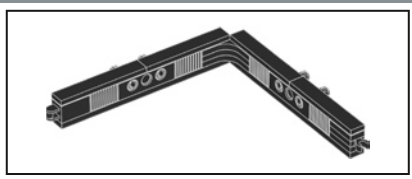

180

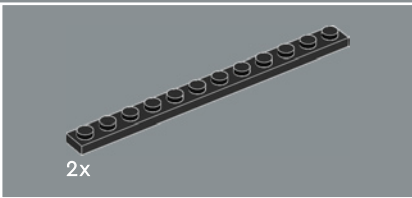
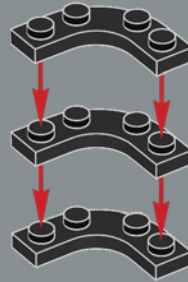

181

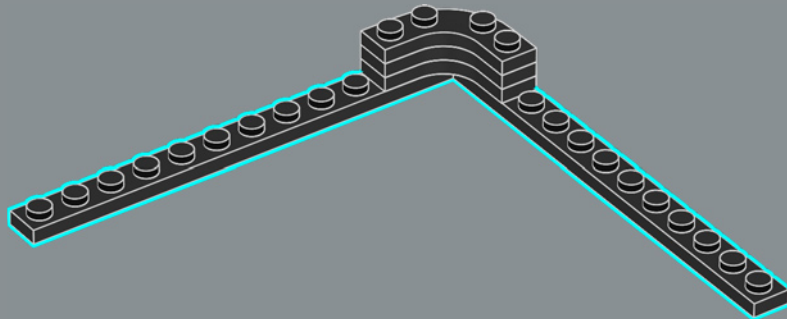

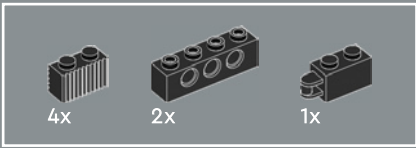

182

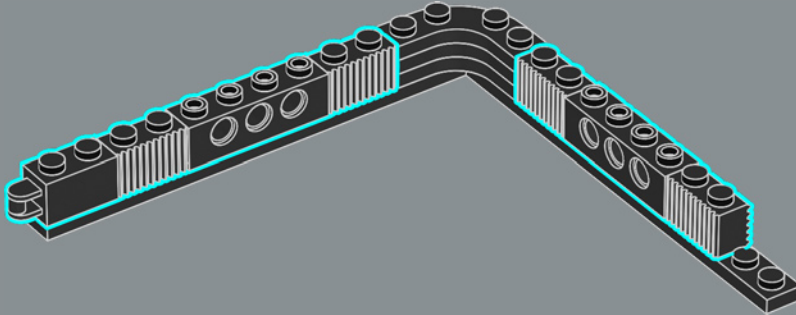



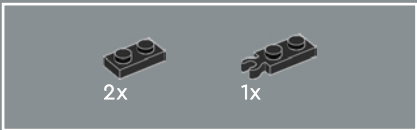

183

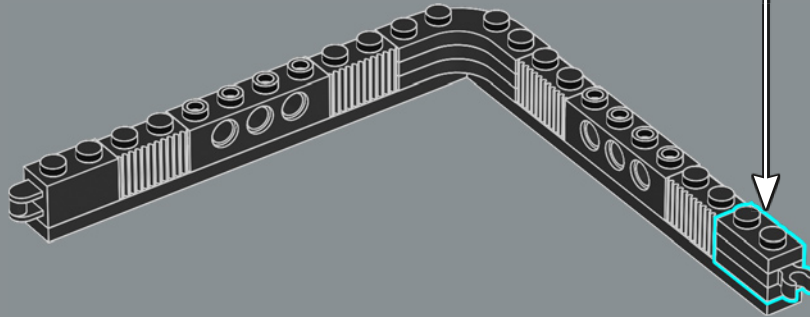
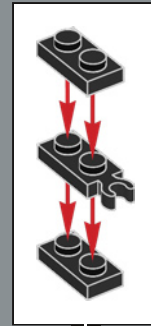

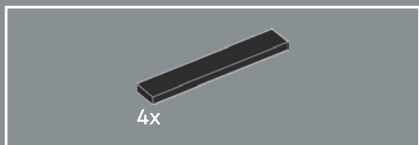

184

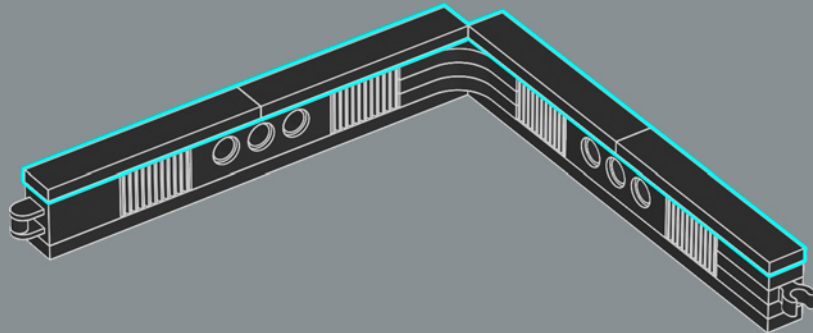

185

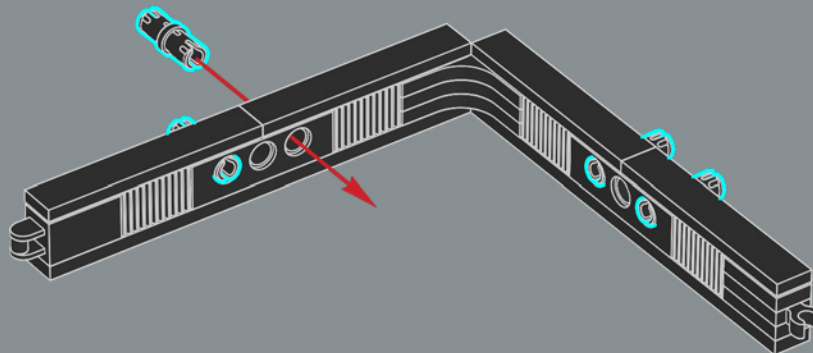

186

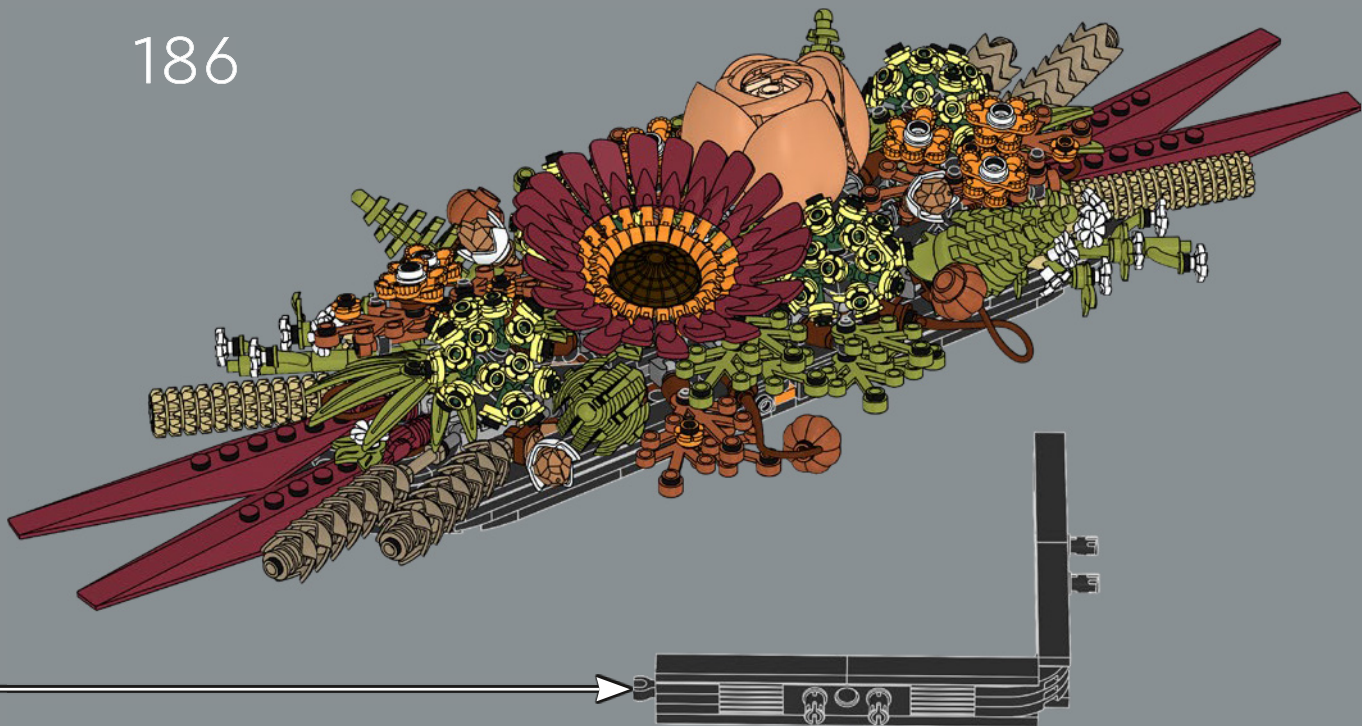



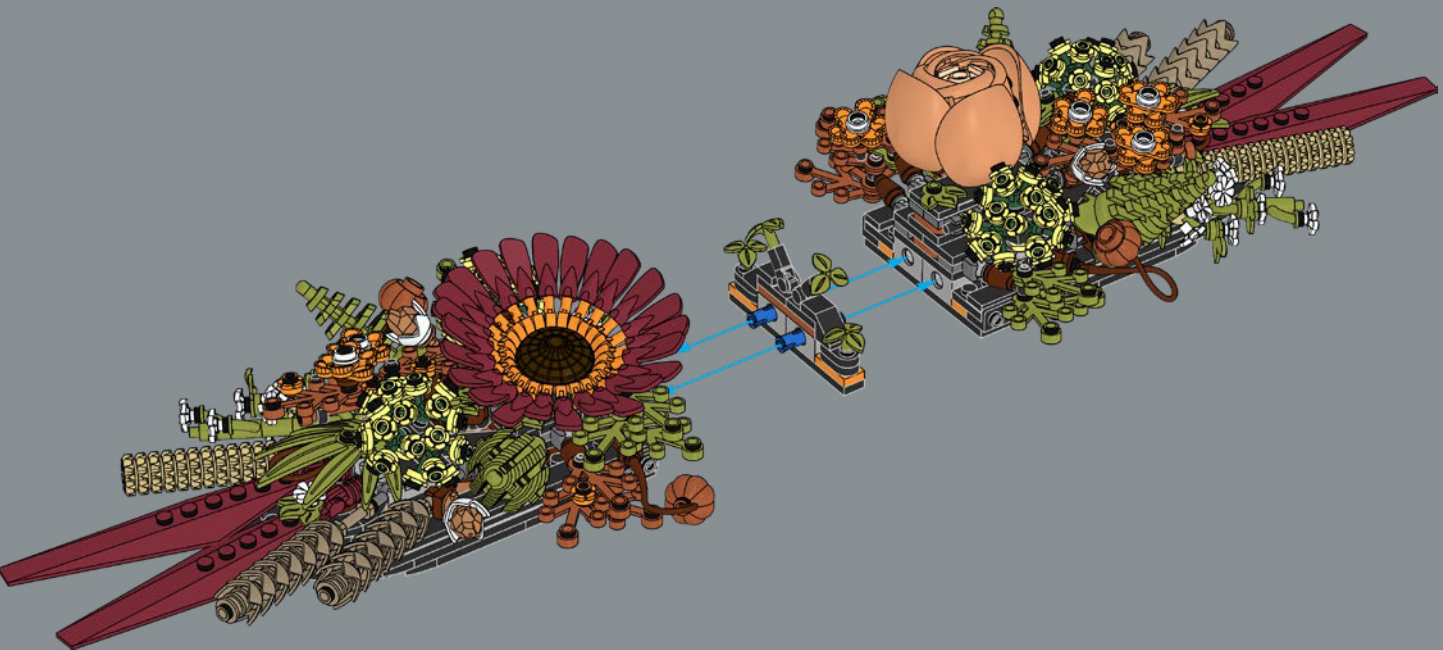

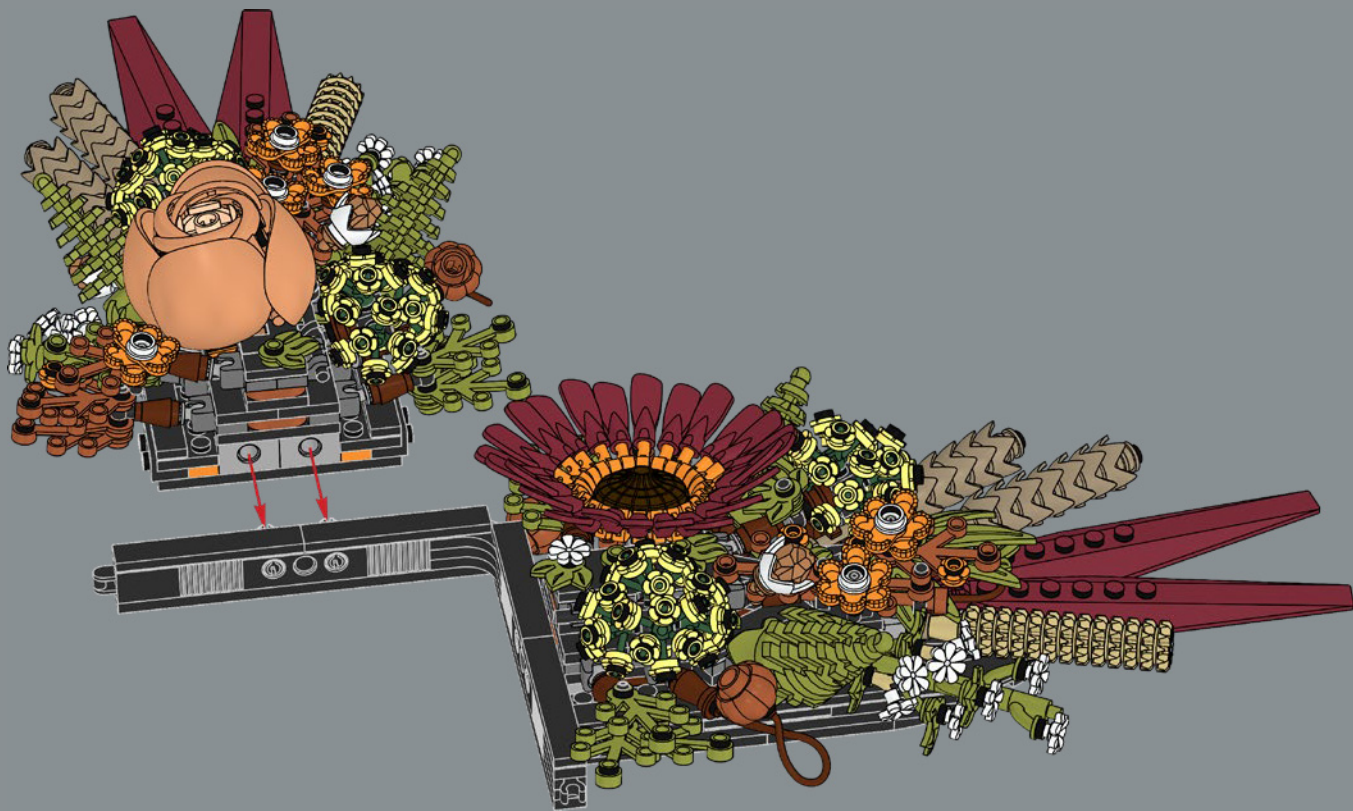



3 x 10314

